

Improving Capacity in Forest Resources Assessment in Kenya (IC-FRA)

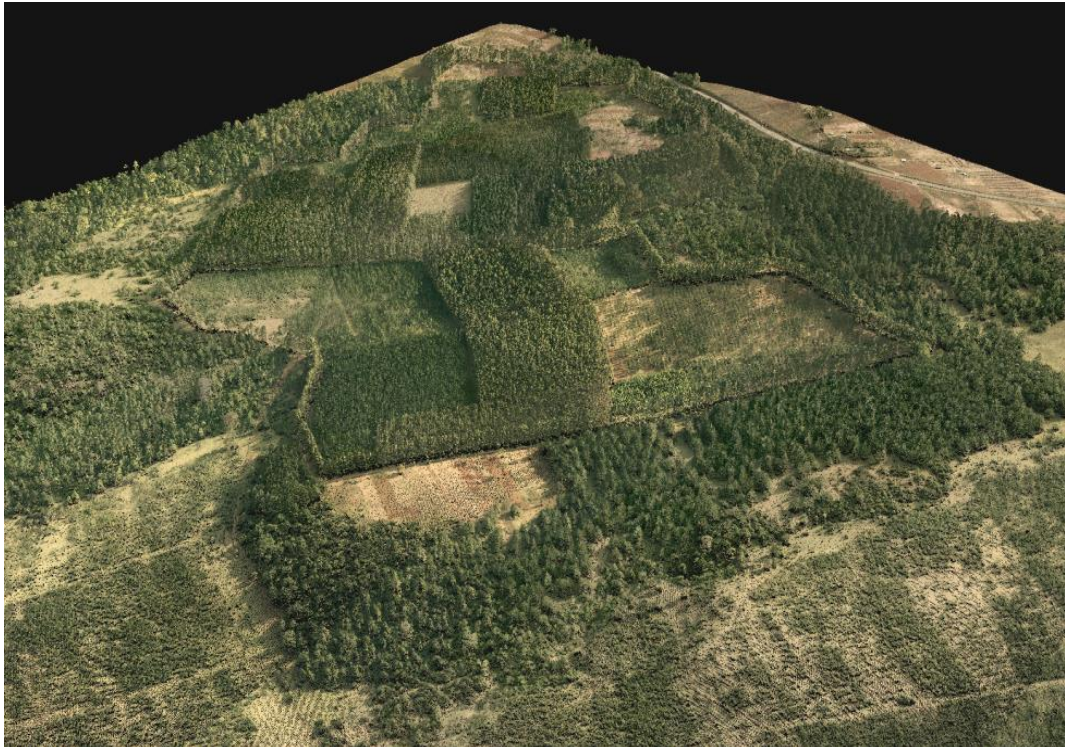

Field Manual for LiDAR Assisted Estimation of Forest Resources in Kenya

May 2016

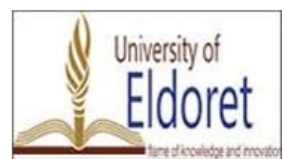

© DRSRS, 2016

All rights reserved. No part of this guide may be reproduced or transmitted in any form or by any means, electronic, electrostatic, magnetic or mechanical, including photocopying or recording on any information storage and retrieval system, without prior permission in writing from either Director Natural Resources Institute Finland (Luke), Kenya Forest Service (KFS), Kenya Forestry Research Institute (KEFRI), Department of Resource Surveys and Remote Sensing (DRSRS); and Vice Chancellor University of Eldoret (UoE) except for short extracts in fair dealing, critical scholarly review or discourse with acknowledgement.

Prepared by:

The Project *Improving Capacity in Forest Resources Assessment in Kenya (IC-FRA)* implemented 2013–2015

Compiled by:

András Balázs, Helena Haakana, Pekka Hyvönen, Heikki Parikka, Fredrick Ojuang, Faith Mutwiri, Peter Nduati

Cover caption:

A true-colour 3D point cloud near Londiani, Kenya

Table of contents

List of figures	3
List of tables	3
List of annexes.....	3
Definitions	4
1 Introduction	7
2 Sampling design	8
2.1 Materials and pre-processing.....	8
2.2 Allocation of reference sample plots	9
2.3 Sampling units	11
3 Preparations for the field work.....	14
3.1 Field crew composition	14
3.2 Preparations	15
3.3 Overview of forms.....	18
4 Data collection in the field	19
4.1 Introduction of the project to local people.....	19
4.2 Access to a sample plot and marking the plot centre.....	19
4.3 Adjusting sample plot location	20
4.4 Guidance on data collection	22
4.4.1 Sample plot information and stand description	22
4.4.2 Tree measurements	27
4.4.3 Small trees	34
4.4.4 Shrubs	34
4.4.5 Bamboo.....	35
4.4.6 Climbers	36
REFERENCES	38

List of figures

Figure 1. An overview of the test areas enclosed in red colour.....	8
Figure 2. False colour aerial imagery (near-infrared, red and green channels) and delineation of the test area in Kericho, approximately 425 km ²	8
Figure 3. False colour aerial imagery and delineation of the test area in Aberdares, approximately 175 km ²	9
Figure 4. Plot of within-cluster sums of squares vs. number of clusters, Kericho dataset.	10
Figure 5. Plot of within-cluster sums of squares vs. number of clusters, Aberdares dataset.....	10
Figure 6. A circular sample plot with a radius (R) of 15 meters.	11
Figure 7. A sample plot on the border of forest stands.....	12
Figure 8. A sample plot on the border of different land use classes.....	13
Figure 9. Subplot layout for small tree measurements.	13
Figure 10. Tree canopy inside the sample plot.	20
Figure 11. Shifting the sample plot centre.....	21
Figure 12. Plot should be moved away from tree.....	21
Figure 13. Example of a sample plot divided into two separate stands.....	22
Figure 14. A schematic of proportional shares in a circle.	22
Figure 15. Distances on slope.....	23
Figure 16. Tree height measurements.....	28
Figure 17. Measurement of DBH with calliper.	29
Figure 18. Diameter measurement in flat terrain.....	29
Figure 19. Diameter measurement of a tree on slope	30
Figure 20. Diameter measurement points for forked tree.....	30
Figure 21. Examples of forks' intersection at the 1.3 m height.....	31
Figure 22. Diameter measurement of living tree lying on the ground with branches growing from the main stem	31
Figure 23. Diameter and stump height measurements of coppice tree.....	32
Figure 24. Diameter measurement of a tree with large buttress.	32
Figure 25. Diameter measurement of deformed trees.	32
Figure 26. Diameter measurement of a damaged and broken stem.....	33
Figure 27. On Left picture is "Mature bamboo" and on the right is "young bamboo".. ..	35

List of tables

Table 1. DBH classes for sample tree selection (unit: mm).	12
Table 2. Equipment by field crews.....	16
Table 3. Equipment by measurement types.....	17
Table 4. Field forms description and corresponding information level.....	18
Table 5. Vegetation types.....	25

List of annexes

Annex 1. Slope Correction	39
---------------------------------	----

Definitions

Afforestation: The establishment of a forest or a stand of trees in an area which had no forest before or where the preceding vegetation or land use was not forestry. (Reforestation is establishing a forest where one was harvested).

Agroforestry: A collective name for land-use systems and practices in which trees and shrubs are deliberately integrated with non-woody crops and (or) animals on the same land area for ecological and economic purposes.

Bole height: Bole height refers to the distance along the main stem of a tree from the base of the tree, above the stump, to the point where utilization of the stem is limited by defect or small size of the diameter.

Breast height: Breast height is the height at 1.3 m from the ground level, or if the ground level cannot be defined, from the seeding point. See more explanations and special cases in the section *Tree diameter measurements*.

Cardinal points: Refer here to the default location (N, E, S, W) of points immediately outside the plot boundary where litter, woody debris, and soil samples are collected.

Dead tree: A tree is regarded as dead if it does not have any living branches and the stem is dry. (Trees that are alive but so badly damaged that they cannot grow in the next growing season (e.g. trees felled by storm) are regarded as dead trees).

Farm forestry: Growing of trees on farms in various configurations or in woodlots for commercial objectives.

Forked tree: If the forking point is below the breast height point (1.3 m), the fork is recorded as an individual tree. If the forking point is above the breast height point, the tree is recorded as one tree.

Ground level: Ground level is described as in the following picture.

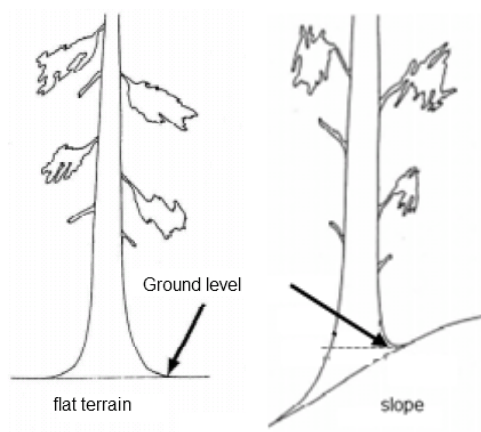

High-precision GNSS (Global Navigation Satellite System): A GPS receiver capable of processing real-time differential correction (DGPS) in the field.

LiDAR (Light Detection and Ranging): a remote sensing technology that measures distance by illuminating a target with a laser and analysing the reflected light; collects 3-dimensional point clouds of the Earth's surface (also called ALS = Airborne Laser Scanning).

Living tree: A live tree must have living branches. The tree must be able to survive at least to the next growing season/next year.

Natural forest: A forest that arose in-situ with little or no human assistance in its regeneration/establishment.

Plot radius, centre and boundary: as in the next figure.

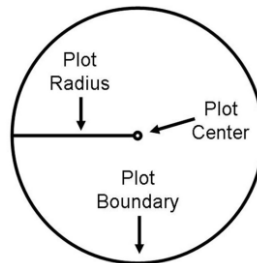

Sample tree: A tree selected for special measurement of variables beyond what is measured in the other trees. (In this manual every 5th tree within a plot was a sample tree where further variables like height were collected).

Seeding point: Seeding point is usually at the ground level. For trees that grow on the top of a stone or old stump, the seeding point is the point where the seeds have started to grow or old stump's sprout.

Shrub: Shrubs are woody perennial plants, generally of more than 0.5 m and (usually) less than 5 m in height on maturity and with many stems and branches.

Stump height: Stump height is the level of the upper most root collar. If no root collars exist, stump height is expected to be 15 cm from the ground level.

Tally tree: Live or dead standing tree in the concentric circular plot above minimum DBH.

Tree: A tree is a perennial woody plant with a height of at least 1.35 m and distinct stem capable of reaching 5 meters in height *in situ*. Cactuses and palms are regarded as trees in the data collecting phase, but distinguished in the data analysis phase. Bamboos and shrubs are not recorded as trees. Climbers such as Ficus are treated as trees.

Tree height: Tree height is the distance along the stem axis between the seeding (base) point and the tree tip. If the seeding point is higher than the ground level (e.g. in cases where a tree growing on the top of a stone), the tree height is measured from the seeding point. See more explanations and special cases in the section *Tree height measurements*.

Acknowledgements

This Field manual for LiDAR Assisted Estimation of Forest Resources in Kenya and other similar inventory design is a product of effort by a large number of people and institutions. The compilers of the manual would initially like to extend their gratitude to institutions that provided staff and allowed them to support this noble initiative.

We most sincerely thank the Government of Finland and Government of Kenya for providing financial support for the IC-FRA Project that has built capacity in terms of staff, equipment and knowledge in LiDAR Assisted Estimation of Forest Resources. Special thanks are extended to Directors of Luke, DRSRS, KEFRI, KFS; and the Vice Chancellor University of Eldoret for allowing their staff to participate in the Project.

This Manual will go a long way in harmonizing field data collection methods for forest resource assessments in Kenya and is a basis for developing an efficient forest monitoring system.

1 Introduction

The main purpose for the “Improving Capacity in Forest Resources Assessment in Kenya” (IC-FRA) project was to improve capacity of the partner agencies in forest resources assessment; to strengthen both human and technological capabilities to collect and manage data, analyse data correctly and disseminate forest information. The project contained two components where component 1 involved planning of National forest inventory and component 2 consisted of development and research work that aimed at utilizing RS material, both satellite and airborne imagery, in estimation of forest characteristics for small areas and in change detection. The Airborne Laser Scanning (ALS or LiDAR) method was tested in forest data collection for operative management planning of tree resources at the local level, and in monitoring of forest cover changes in areas of high interest, such as closed-canopy natural forest. Airborne Laser Scanning (ALS) and aerial image acquisition was piloted in two areas (Kericho and Aberdare) in Kenya in February 2014.

The aim of the exercise was to introduce modern, LiDAR based forest inventory method and explore the possibility to use such data in estimation of forest stand characteristics and inventorying areas with poor accessibility.

In order to produce reliable wall-to-wall maps of various forest attributes including total growing stock and average height, ground truthing was carried out by measuring reference sample plots in the test areas. The optimal amount and allocation of reference plots was guided by the data already acquired so as to optimize the sampling design bearing in mind the results’ accuracy and financial limitations. The aim of the field measurements was to capture the vegetation on the sample plots as accurately as possible in accordance with financial limitations.

The manual focuses on:

- sampling design;
- measurement practices;
- biophysical variables; and
- inventory field forms.

The guidelines for using a GNSS (global navigation satellite system) receiver, i.e. high precision GPS, are not included in this document but are outlined in the Manual on GNSS data collection with Javad Triumph-2.

2 Sampling design

2.1 Materials and pre-processing

The areas assessed were located in Kericho and Aberdares (enclosed in red colour), (Figures 1-3).

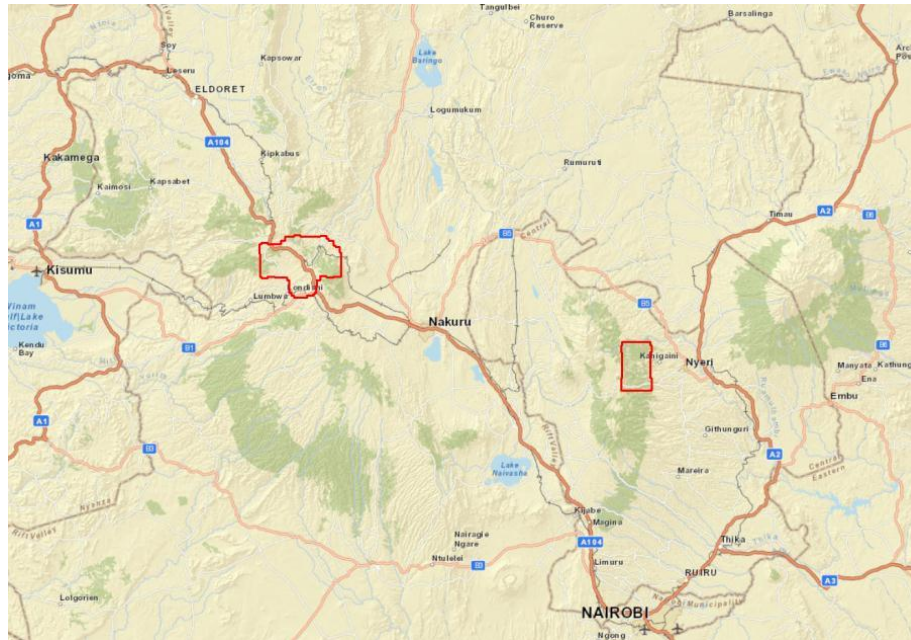

Figure 1. An overview of the test areas enclosed in red colour.

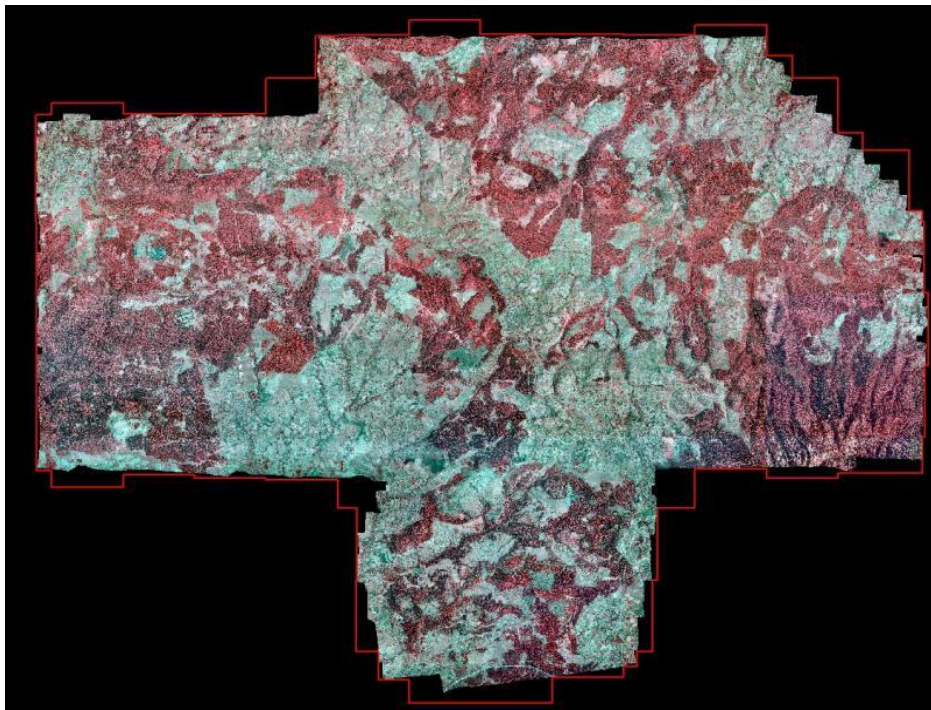

Figure 2. False colour aerial imagery (near-infrared, red and green channels) and delineation of the test area in Kericho, approximately 425 km².

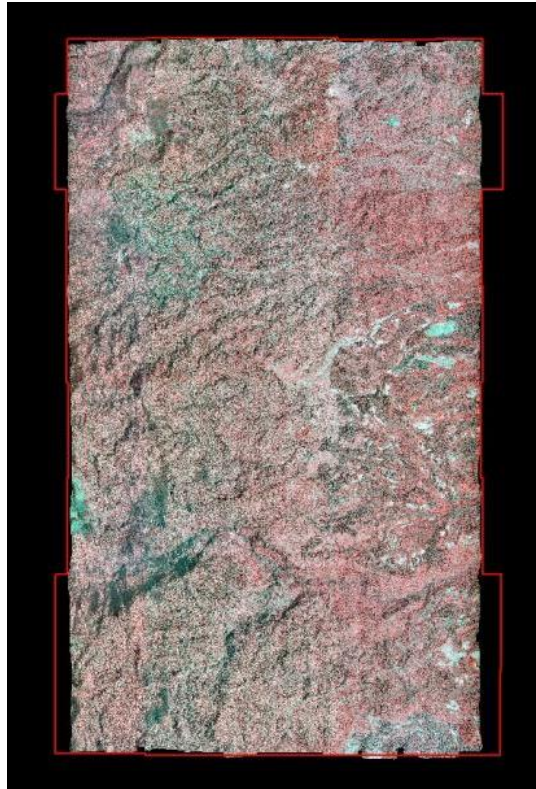

Figure 3. False colour aerial imagery and delineation of the test area in Aberdares, approximately 175 km².

The acquired laser data with approximately 2 points/m² was pre-processed: noise and faulty returns removed and heights above ground for each return calculated. The colour infrared aerial imagery was re-sampled from the original 25 cm resolution to 50 cm, which was found to be an optimal resolution for forest inventory purposes.

2.2 Allocation of reference sample plots

A grid over each test area was generated with a cell size of 26.5 x 26.5 m. The cell size corresponds to the area of a reference sample plot of radius 15 m. For each grid cell four features were calculated from the laser and aerial image data. The selected features correlated strongly with some important characteristics of land-cover and vegetation types, thus making the classification of grid cells possible. The selected features were:

- **h85f**: laser feature, 85 percentile of first pulse canopy heights (85% of the first pulse canopy height observations fall below this height), correlates strongly with vegetation height;
- **vegf**: laser feature, proportion of vegetation returns (height of return above ground \geq 2m) from all returns (first returns), correlated strongly with vegetation cover;
- **meannir**: raster feature, average of pixel values of near-infrared channel, correlated with different vegetation types and tree species groups;
- **idm**: Inverse Difference Moment, raster feature, also called Homogeneity, correlated with forest-non-forest land-cover types (forest: low homogeneity) and canopy structure

Based on these features the grid cells were clustered (classified) using the k-means tool of the Stats package in R. The tool kmeans “aims to partition the points into k groups such that the sum of squares from points to the assigned cluster centres is minimized” (kmeans help page in R).

K-means clustering requires the number of clusters (classes) to be defined in advance. The number of clusters used in this exercise was calculated by running kmeans with a set of a number of clusters to be considered. For each test run the total sum of squares within clusters (the sum of the squared distances of observations from the cluster centres) was plotted. It is expected that the sum of distances will decrease rapidly as the

number of clusters increase but the curve will flatten after a while. The bend in the curve provides the optimal amount of clusters. Based on the test runs and the plots (Figures 4 and 5), the number of clusters, i.e. homogenous classes in respect of the selected features, chosen for kmeans was 130 and 100 in the Kericho and Aberdares datasets, respectively.

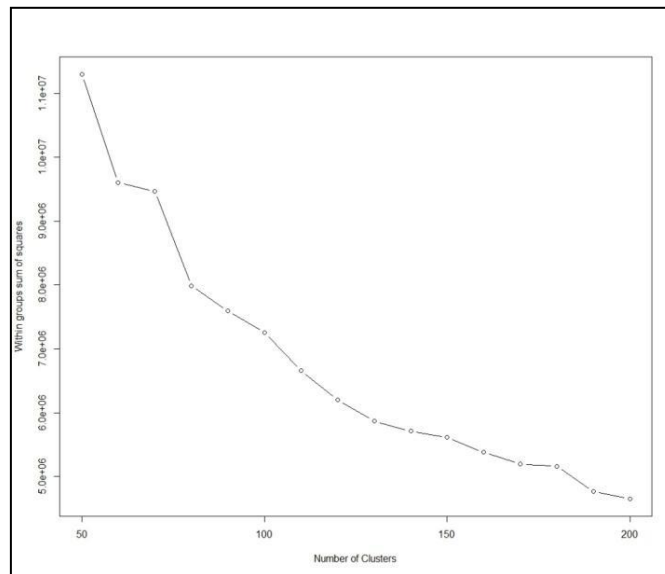

Figure 4. Plot of within-cluster sums of squares vs. number of clusters, Kericho dataset.

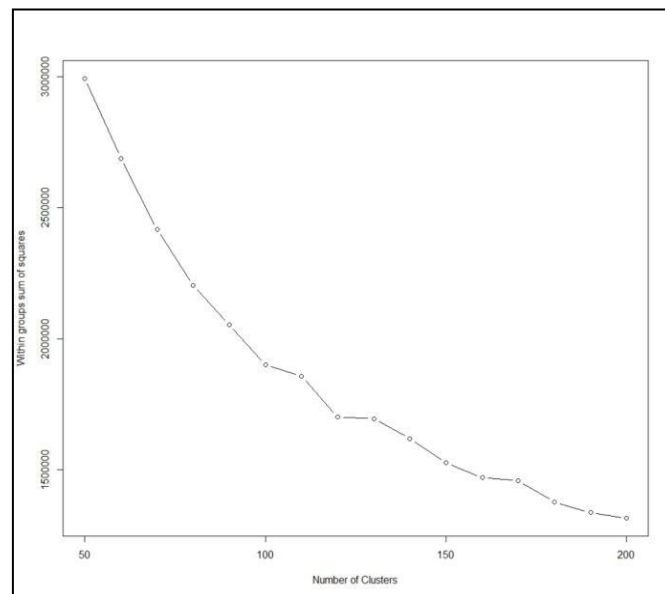

Figure 5. Plot of within-cluster sums of squares vs. number of clusters, Aberdares dataset.

The total number of sample plots allocated to the two test areas was 524. It was calculated by assuming that four field crews in 2.5 months (50 working days) can measure 3 and 2 plots/day in Kericho and Aberdare, respectively. The sample plots were divided between the test areas proportional to their sizes: Kericho 371 plots and Aberdare 153 plots.

As our interest was in woody vegetation, grid cells with very few vegetation returns ($vegf < 10\%$) were excluded from the process. At the same time classes with very low h85f values (all or nearly all h85f values equal to zero in the same class) were discarded. It is important to state wall-to-wall estimation of forest attributes using k-nearest neighbour method requires “zero-volume” samples and they can be generated indoors.

The sample plots were allocated to the classes proportional to the area covered by a particular class (proportional allocation). In order to decrease time used for moving from one plot to the next, sample plots were grouped together. The size of groups was defined according to the assumed amount of plots to be measured in one field day. A group consisted of one preselected “main” plot and one or two “accompanying” plots. The groups were formed using the following criteria:

- main plots have to be at a distance of at least 300/500 m from any other plot (Kericho/Aberdares);
- two plots from the same class are not allowed in the same group;
- accompanying plots have to be at a distance of 100-200 m from the main plot; and
- accompanying plots have to be at a distance of least 100 m from any other plot;

Main plots were allocated into the classes with the highest area coverage. Each class was further divided into subclasses. The number of subclasses was equal to the number of plots to be allocated into the class. Accompanying plots were selected around the main plots from the classes with less coverage.

2.3 Sampling units

The primary sampling unit is a circular plot with a radius of 15 meters (Figure 6) which is guided by Kenya’s biophysical survey manual for such vegetation types¹. It was assumed that 3 plots/day and 2 plots/day could be measured in Kericho and Aberdares respectively.

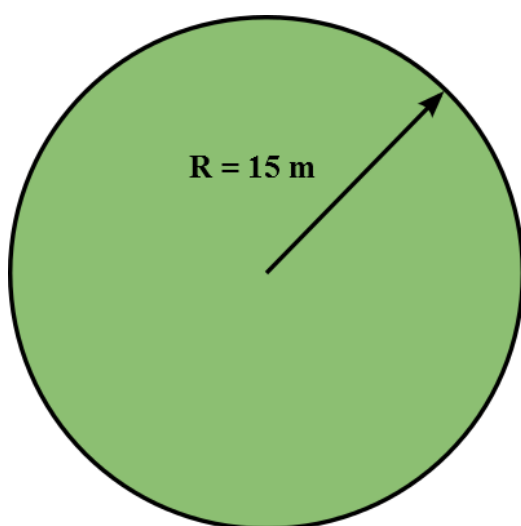

Figure 6. A circular sample plot with a radius (R) of 15 meters.

The aim of the field measurements in this exercise was to capture the total amount of woody vegetation on the sample plots. All trees within 15 m radius with a diameter of at least 5 cm at breast height (1.3 m above ground, (DBH) are tallied at the stand level. For each tally tree, the species name and DBH were recorded. Sample trees were selected in various DBH classes (Table 1).

¹ Field Manual for Biophysical Forest Resources Assessment in Kenya – ICFRA, 2016

Table 1. DBH classes for sample tree selection (unit: mm).

DBH>	DBH<
49	100
99	150
149	200
199	250
249	300
299	350
349	400
399	450
449	500
499	600
599	700
699	800
799	900
899	1000
999	

In each DBH class the 1st tree is a sample tree and every other 5th tree. In order to simplify the selection process of sample trees, dead and broken trees were not counted and these trees cannot become sample trees, except in the last class. Living and dead trees with a DBH of at least 1 m and without broken tops were always measured as sample trees. The stem height of trees with broken tops were recorded separately.

Stand level information was collected and recorded about land use, vegetation type and any kind of observable logging since the data acquisition on the 11-13th February 2014 (Kericho) and 10th February 2014 (Aberdares). In case a sample plot was located on a stand border, i.e. there were different land use classes or vegetation types within the plot (R=15 m), stand variables were recorded for both stands. However, multiple stands were described only in obvious cases, e.g. forest stands of different age, species composition (see Figure 7), forest-agricultural land (see Figure 8). Printed aerial photographs can be used for verification.



Figure 7. A sample plot on the border of forest stands.



Figure 8. A sample plot on the border of different land use classes.

Additionally, the amount of small trees (DBH < 5 cm and height \geq 2m) was recorded on 4 circular subplots with a radius of 2.82 m. The centres of the subplots were at 7 meters distance from the plot centre in the four cardinal directions (Figure 9).

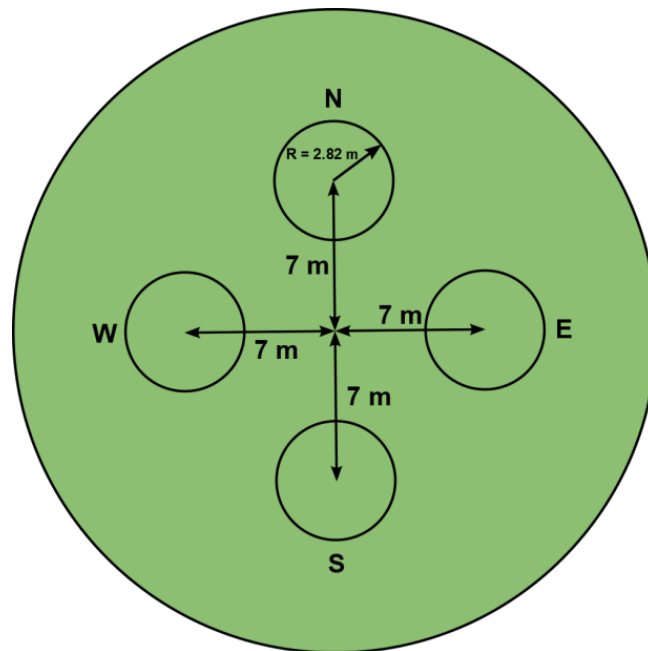

Figure 9. Subplot layout for small tree measurements.

In case there were multiple stands on the sample plot, the subplots were divided between the stands proportionally to the area covered within the plot (i.e. if stand A covers approx. $\frac{3}{4}$ of the area of the plot, 3 subplots were established in stand A and one in stand B). If the location of the stand border did not allow using the cardinal directions, the subplots were evenly distributed within the stands.

Shrubby vegetation was captured by recording its mean height and relative coverage within a sample plot with a radius of 15 m. Information about bamboo was recorded within the sample plot (15 m) by groups. In cases where it was evenly distributed over the sample plot area two subplots with radius of 2.82 m situated 7 m west and east directions from the sample plot centre were used.

3 Preparations for the field work

This part includes recommendations to prepare and carry out fieldwork activities. The fieldwork is described step by step for a sample plot, together with recommendations on the data collection techniques.

3.1 Field crew composition

A recommended field crew consists of the following members:

- 2 Inventory foresters
- 1 Local forester (warden if measurements are carried out in a national park)
- 1 GNSS expert
- 1 Taxonomist
- 2 Rangers
- 1 Driver
- 1 Casual (if necessary)

The responsibilities of each crew member must be clearly defined and their tasks are proposed as follows below.

The **crew leader** is responsible for:

NB: One of the inventory foresters is the crew leader and the other the assistant crew leader.

- Organizing all the phases of the fieldwork, including observations, measurements and data collection. He/she has the responsibility of contacting and maintaining good relationships with the community and the informants and has a good overview of the progress achieved in the fieldwork and is also responsible for maintaining harmony and good working spirit within the crew. The crew leader is also responsible for the quality of work of the crew members.
- The specific responsibilities of the crew leader includes: preparing the fieldwork and collecting the maps.
- Planning the work schedule for the crew in an efficient way.
- Contacting local forestry officers, authorities and the community, introducing the survey objectives and the work plan to the local forestry staff and authorities, identify informants, guides and workers.
- Administer the location and access itinerary of clusters and plots.
- Taking care of logistics of the crew: organize and obtain information on accommodation facilities; recruit local workers; organize access to the clusters.
- Locating of the sample plot centre coordinates, description of the surrounding area, determining of the stand subdivision, determining of slope corrections on sloping areas, and recording of tree measurements.
- Filling in the forms and taking notes.
- Ensuring that field forms are properly filled and that the collected data are reliable.
- Organizing meetings after fieldwork in order to sum up daily activities.
- Organizing the fieldworkers' safety.
- Download data into the computer.

The **assistant of the crew leader** will:

- Help the crew leader to carry out his/her tasks
- Take necessary field measurements and observations
- Make sure that the equipment of the crew is always complete and operational
- Supervise and orient the workers

- Filling in the forms and taking notes as required
- Take-over in the team leader's absence

The crew members measure tally trees, sample trees, small trees and record plot and stand information.

The **taxonomist** is responsible for identifying tree, bamboo and shrub species. He/she will assist in taking other measurements.

The **GNSS expert** is responsible for setting up the GNSS receiver at the base station and the plot centre and post-processing and correcting the data captured. He/she will assist in taking other measurements.

The **ranger** is responsible for providing safety to crew and providing local knowledge of how to access the sample plots. In Aberdare rangers will also provide security to the crew.

The **local forester** is responsible for providing local knowledge of how to access the sample plots and being in contact to locals if measurements have to be carried out on private land.

The **driver** is responsible of taking crew members to a point near sample plots and guarding equipment (if left in the car).

One **casual** from the local communities can be recruited to assist in the measurements when necessary.

Training of the crews on the survey methodology is undertaken in theoretical and practical sessions in the beginning of the fieldwork where techniques of different forest and tree measurements and data entry are explained and practiced. Where possible, team leaders should check data and notify of anomalies or suspect entries within the shortest time possible (preferably a day after the cluster measurement).

3.2 Preparations

Field work missions are planned by the Forest Inventory Field Officer. He/she ensured that the necessary field forms and maps to cover the clusters are prepared and assigned to each crew. The forms are described in details in chapter 4.4.

The preparation of the actual fieldwork consists of the following phases:

- A. Contacts to local KFS office and local communities
- B. Preparation of the PDA or smart phone (with programs and data), securing field forms and maps
- C. Field equipment (maintenance, checking)

A. Guidance on contacts to local KFS office and local communities

Each field crew, through its leader, should start its work by contacting key staff in the target area in order to get information and access to the area where the sample plots are located. These local staff may help in contacting the authorities and land owners in order to introduce the field crew and its programme of work in the area. The local staff may also provide information about access conditions to the site and about the people who can be locally recruited as guides or workers. They may also inform the local people about the project.

B. Guidance on preparation of the phones (with applications and data), securing field forms and maps

Preparation of the smartphones used in the data entry is described in a separate document. The crew leader must ensure that enough paper forms are available to carry out the planned field data collection, in case of problems with electric devices. Maps and printed aerial photographs covering the study area should be prepared in advance to help the orientation in the field. These may be enlarged and reproduced, if necessary.

Prior to the field visit, each crew must plan the itinerary to access the sample plot, e.g. Google Earth, topographic maps, whichever will be the easiest and least time consuming. Sample plot coordinates should be

uploaded to the GPS before starting the field campaign. Advice of local informants (local forestry staff, for example) are usually valuable and help save time in searching the best option to access the sample plots.

The sample plot locations will be delineated on topographic maps and on aerial photographs. The plot locations are to be indicated together with their respective coordinates in the UTM coordinate system (Arc 1960 Universal Transverse Mercator Zone 37S).

An enlarged section of the map corresponding to the area surrounding the plot will be prepared (photocopy or printed copy) and used to draw the access itinerary.

Measuring order of the sample plots may vary according to conditions of accessibility and is determined during the preparation phase.

Reference objects (roads, rivers, houses) that contribute to the better orientation of the crew in the field should be identified during the planning phase.

The numbers of the sample plots are entered into the GPS receiver according to the following rule:

- 1st digit: test area code (1=Kericho, 2=Aberdare)
- 2nd-4th digits: sample plot codee.g.: 1007, 2115.

C. Field equipment per crew

The equipment needed by each field crew is described in the following table.

Table 2. Equipment by field crews.

Equipment needed	Number required	Comments
Measurement tools		
Compass (360°)	1	In degrees Water proof model
Bluetooth GPS receiver (precision ca. 2 m)+ charger	1	
GNSS receiver (precision < 30 cm) and accessories	1	
Measuring tape, 50 m	2	Metric, 1 cm units (fibreglass)
Calliper for small trees (<30 cm)	1	Metric, 1 cm units
Diameter tape	1	mm scale
1.3 m stick	1	For measuring tree's breast height level
2.82 m stick	1	For measuring small trees
Tree height and land slope measuring equipment	1	Laser Ace, Haglöf Vertex hypsometer, TruePulse or Suunto hypsometer with 15m, 20m and % scales to measure both tree height, in meters; and slopes, in percent.
Spherical densiometer	1	Canopy coverage measuring equipment. Convex model. " ∩ "
Coloured flagging ribbon	Several rolls	For marking
Waterproof bags to protect measurement instruments and forms in case of rain	As necessary	
Machete / Bush-knife	As necessary	For bush clearing
Pocket knife	1	For general use

Colour spray	1	For marking of fixed points on PSPs
Clothing		
Boots and waterproof outfits	For permanent team members	
Helmet	For permanent team members	Optional, for area where there is risk for branches to fall
Rain coats	As necessary	Optional
Documents, papers		
Field forms	As necessary	Also plastic ones for rainy days
Code check list with slope correction table	As necessary	Needs to be laminated
Field manual	As necessary	
Flora and species check list	As necessary	
Topographic maps, field maps	As necessary	
Smart phone	1	To enter data in the sample plot
Laptop PC	1	To enter/transfer field data into/from PDA
Pencils and markers	As necessary	
Hand calculator	1	
Clipboard	2	To take notes
Newspapers	As necessary	For collection of samples (plants/leaves)
Other equipment (camping, security, communication...)		
Chain saw	1	When necessary
First aid kit	1	With phone numbers of nearest hospitals / emergency centres
Flashlight and batteries	As necessary	
Camping equipment and cooking utensils	As necessary	
Rucksack	As necessary	
Water and food	As necessary	

The list of equipment is specified by measurement type in the following table (Table 3.). The condition of the inventory equipment needs to be verified prior to field work and missing or damaged items are replaced with new or fixed tools.

Table 3. Equipment by measurement types

Measurement type	Equipment required
SAMPLE PLOT	
Sample plot locations	Bluetooth GPS, maps, list of sample plot coordinates, GNSS
Tree location determination	30 m measuring tape, slope correction table, 1.3 m stick, callipers and compass
Slope	Haglöf Vertex hypsometer, TruePulse or Suunto hypsometer with clinometer
TREES	
Species code and name	Species check list
Tree diameter	1.3 m stick; callipers and/or diameter tape (mm scale)
Stump diameter	Callipers and/or diameter tape
Tree height	Laser Ace or Suunto hypsometer
Bole height	Laser Ace or Suunto hypsometer
Stump height	Measuring tape

SHRUBS AND SMALL TREES	
Shrub coverage	If applicable use spherical densiometer
Mean shrub height	If applicable use Haglöf Vertex hypsometer or Suunto hypsometer
Number of small trees	2.82 m stick
BAMBOO	
Species code and name	Species check list
Bamboo average diameter	Diameter tape or callipers
Bamboo average height	Laser Ace or Suunto hypsometer

3.3 Overview of forms

There are 6 different forms for biophysical data, as indicated in the next table (Table 4.).

Table 4. Field forms description and corresponding information level

Form No.	Information
1	Sample Plot: General plot description data
2	Stand: General stand description data
3	Trees: Tree measurements (DBH \geq 5 cm)
4	Small tree measurements (DBH < 5 cm)
5	Shrubs: Coverage and mean height of shrubs/bushes
6	Bamboo measurements

Note when using paper forms: if a sample plot contains so large number of trees/dead wood/bamboo clumps that all data cannot be accommodated in one single form sheet; additional form sheets in continuation may be used.

The sample plots are pre-indexed and identified on the printouts of topographic maps and as waypoint data in the smart phones' Android application called Locus.

4 Data collection in the field

4.1 Introduction of the project to local people

The Field crew must establish contact with local people on arrival at the site by meeting with contacted persons including village representative, closest government institution and owners and/or people living in the cluster area. Therefore, it will be necessary to contact the local population before visiting the area in order to inform them about the visit and request for permission to access the area. This may be done by holding an introductory meeting.

The crew must briefly introduce and explain the aim of the visit and study. A map or an aerial photograph, showing the target inventory area, may be very useful to facilitate the discussion. It is important to ensure that both local people and the field crew understand which area will be studied. The aim of the inventory must also be clearly introduced to avoid misunderstandings or raise false expectations. Cooperation and support from local people are essential to carry out the fieldwork. It is easier to achieve this support if the first impression is good. Nevertheless, it must be stressed that the fieldwork consists only of data collection and not local development or law enforcement project.

4.2 Access to a sample plot and marking the plot centre

Sample plot locations will be pre-drawn on the topographic maps. Reference coordinate system with grid and sample plot locations can also be drawn on aerial photographs. In some cases a local guide will be useful to access the sample plots more easily.

Locating a sample plot in the field will be done with the help of Bluetooth GPS where the location of each sample plot is registered as waypoints. The precise location of the sample plot centres will be measured with high precision GNSS devices. The measurements will be post-processed and corrected targeting to an approximate accuracy of 10-30 cm. The team should aim to find the predefined sample plot location with an accuracy of approximately 1-5 m, aided by 50 cm resolution aerial photographs on the smart phones. The procedure to locate sample plots in the field with the help of GPS is following:

1. Plan the route to the sample plots in good time, at least in the previous evening. If using a car to get to the sample plots, mark the car park (where to leave the car) in the GPS as a waypoint. Mark also other possible waypoints.
2. Use the map and aerial photographs to navigate to the car park, check the point with the GPS.
3. Navigate to the sample plot with the help of printouts and the GPS.
4. When arriving near the sample plot (~10–20 m), select an open point where the GPS works well or gets good position. Collect GPS data for 2–5 minutes to get a fixed position. The GPS will average the collected data and calculate the current location and display the remaining distance and bearing to the sample plot.
5. Use the compass and measuring tape to reach the sample plot centre. Check the correctness of the centre location on the aerial photographs if possible.

The sample plot centre is marked with a wooden peg in order to facilitate easy re-location if the tree measurements cannot be finished in one day.

The high precision GNSS device will be set up at the sample plot centre. If due to dense vegetation cover GNSS measurements are not possible at the plot centre, two auxiliary points have to be measured from the proximity of the plot centre, where satellite signal reception is sufficient. The distance and bearing from the plot centre are recorded on the survey form.

Handling of the GNSS device and conducting the measurements are discussed in a separate manual²

²Manual on GNSS data collection with Javad Triumph-2

Note that all distances measured and referred to must be horizontal distances! Use slope correction table provided in Annex 1. Slope Correction Note: If TruPulse, Vertex or similar instruments are used for measuring distances, they automatically correct for the slope.

The sample plots can be measured in any sequence; this is decided during the preparatory phase. However, the crew must follow the original sample numbering when recording the data into the smart phones or paper forms.

4.3 Adjusting sample plot location

Due to various reasons some of the plots may not be accessible. In such cases the plots have to be moved to a similar location and as close to the original as possible. Suitable locations can be found with the help of aerial imagery and observation on the field. The plot **location is changed only if it is totally inaccessible**. The reason for adjustments will be recorded on the survey form.

The first activity immediately the plot centre is located is to check if there were any trees removed from the plot since the date of Laser data acquisition. If without doubt trees were removed, the plot centre has to be moved. The general rule is to stay in the same forest stand where the original plot was supposed to be. If the entire stand is clear-felled or affected by removal of trees, move the plot to the next forest stand. Printouts of aerial photographs and observation on the field can help to make the right decision.

As it was stated before, the aim of this survey is to capture the vegetation in the sample plots as accurate as possible. In some special cases it is required to take into account what the sensors “see” and what will be captured on the field. In Figures 10 and 11) and, the canopy of the tree indicated by light green arrow, reaches over the sample plot but is not measured as its stem is outside the plot. The tree is significantly higher than the sampled trees in the plot.



Figure 10. Tree canopy inside the sample plot.

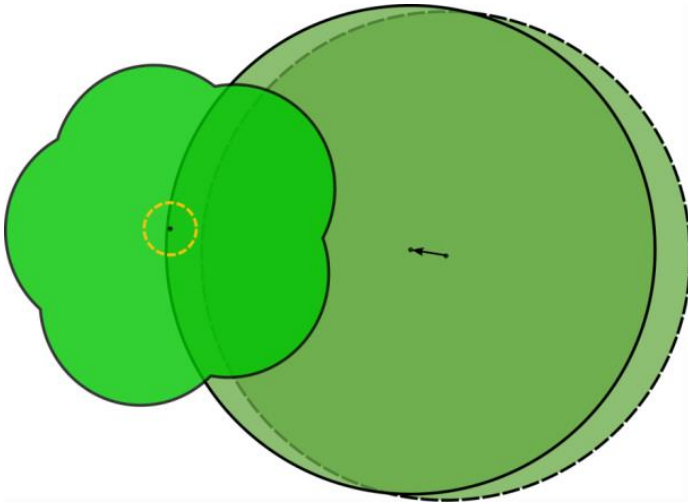

Figure 11. Shifting the sample plot centre.

In such cases the plot centre should be shifted either towards the tree (the tree will be measured) or away from the tree (the canopy is outside the sample plot). Decision should be made with the help of aerial photographs and observation on the field. If there are other trees with similar characteristics within the same forest stand, the plot centre should be shifted towards the tree (like in Figure 10). The plot centre should be shifted in a way that the tree's estimated base centre point is within the sample plot (Figure 11).

If there are no similar trees in the stand, the plot centre should be shifted away from the tree so, that its canopy is outside the sample plot. In the case shown in Figure 12 the plot should be moved away from the tree as it is clearly an outlier compared to the rest of the trees in the stand.



Figure 12. Plot should be moved away from tree.

In another special case the sample plot centre might be on a road or railway. If traffic makes GNSS and other measurements impossible, the plot centre should be moved off the road or railway.

4.4 Guidance on data collection

4.4.1 Sample plot information and stand description

A separate copy of Sample Plot Form will be filled for each sample plot. The forms contain general data describing the sample plot, including the information on its identification code and whether the plot can be accessed or not.

A sample plot maybe divided into several stands. Separate stands are distinguished if there are different land use classes or vegetation types within the outermost radius ($R = 15\text{ m}$) of the plot (Figure 13).

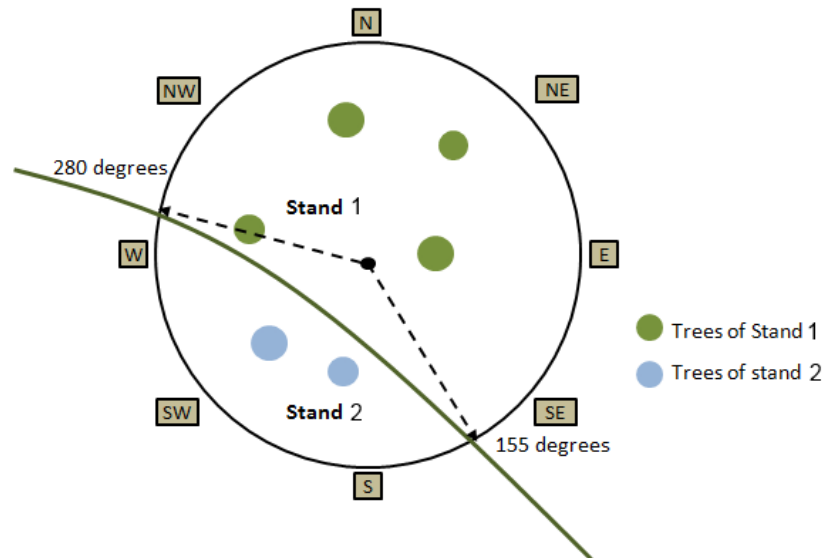

Figure 13. Example of a sample plot divided into two separate stands.

On a shared sample plot (i.e. at the border of two land use classes / vegetation types) the crew needs to fill in two or more forms for the same sample plot, so that the sample plot is divided into parts 1 and 2 (and 3, etc., if required). The part of the sample plot where the sample plot centre point is located is recorded as Stand 1³. The share of each stand is presented as percentage of the total sample plot area within a circle of 15 m radius; see Figure 14. for quick help.

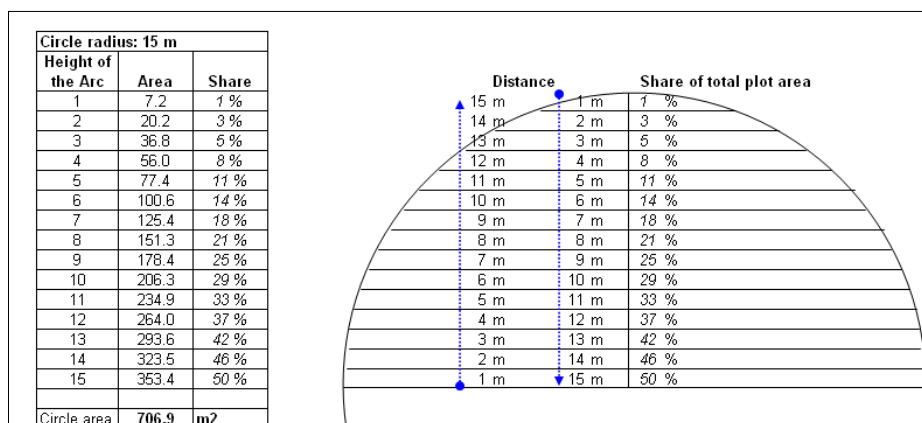

Figure 14. A schematic of proportional shares in a circle⁴.

³ Adopted from Kangas and Maltamo (2006), p. 193.

⁴ Computed using Circular Arc Calculator available at <http://www.handymath.com/>

Slope corrections

All reference distances, such as the distance from a tree to the sample plot centre point, are expressed as horizontal distances. Thus, sample plot areas are also computed upon horizontal plane. When the terrain is flat, distances can be measured directly, but on sloping terrain the horizontal distances differ from the direct distances (see Figure 15). A corrected distance is taken from a slope correction table (Annex 1. Slope Correction) and these distances are applied at all slopes above or equal to 5 percentage.

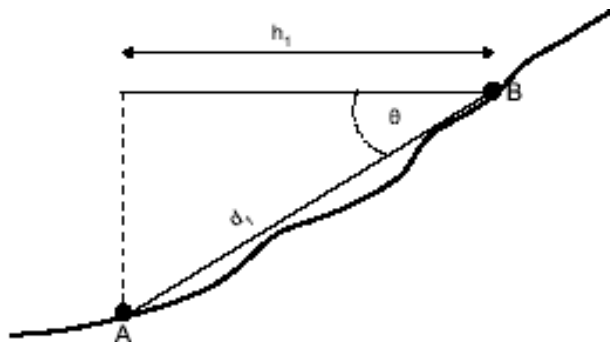

Figure 15. Distances on slope.

The distance between two points, measured along slope (d_1) is always longer than an equivalent horizontal distance (h_1). On slope terrain, the horizontal distance must be multiplied by a factor that corresponds to the inclination, in order to obtain a corrected distance).

Slope is measured using a Haglöf Vertex hypsometer, TruPulse, clinometer or Suunto hypsometer. The unit in this inventory is percentage. Note: TruPulse, Vertex or similar instruments automatically correct for the slope. Where distances are measured using a measuring tape on sloping ground, slope distance will need to be corrected back to horizontal using the following equation:

$$\text{Horizontal distance} = \text{Slope distance} \times \cos(\sigma)$$

Where σ = slope angle in degrees.

The equation can be written in the following form when slope angle is in percentages:

$$\text{Horizontal distance} = \text{Slope distance} \times \cos(\text{Atan}(\alpha/100))$$

Where α = slope angle in percentages (%).

The slope correction table for distances is presented in Annex 1.

SAMPLE PLOT FORM

Sample plot number

Sample plot number from the inventory field map.

Date

Date when the measurements on the sample plot are done.

Group leader

Name of the group leader.

Adjustment of sample plot location

Condition of accessibility and location adjustment is recorded for each sample plot.

- 0 Accessible, not moved.
- 1 Moved due to slope.
- 2 Moved due to owner refusal; owner does not allow one to enter the site.
- 3 Moved due to restricted area; e.g. military or border areas.
- 4 Moved due to water body.
- 5 Moved due to logging since Laser data acquisition date (February 2014)
- 6 Moved due to tree crown.
- 7 Moved due to road/railway.
- 99 Moved due to other reason; specify in Remarks.

GNSS positioning of sample plot centre

Code indicating if the GNSS measurements were carried out at the sample plot centre or not.

- 0 GNSS positioning at the sample plot centre.
- 1 GNSS positioning not at the sample plot centre.

Distance of auxiliary GNSS point (m)

Horizontal distance of auxiliary GNSS point from sample plot centre in meters with 0.01 precision.

Bearing of auxiliary GNSS point (degrees)

Bearing of auxiliary GNSS point from sample plot centre in degrees.

STAND FORM

Stand

Code indicating the stand in the sample plot. The sample plot is shared into several stands in case it is situated on the border of more than one land use/vegetation types. Note, minimum width for roads, power lines etc. in stand delineation is 5 metres.

- 1 Stand where the sample plot's centre point is located.
- 2 The second stand etc.

Share

Stand's estimated share of the total sample plot area from 1 to 10 (10 being 100%).

Land use class

Land use class refers to the dominant land use purpose at the time of observation. Note, minimum width for roads, power lines etc. is 5 metres in classification.

- 1 Production forest: Land designated for production and extraction of products. E.g. wood, fibre, bioenergy, and/or non-wood forest products.
- 2 Protection forest: Protected forest lands. Including also nature reserves, soil conservation, water and watershed protection, protection against erosion and landslides.
- 3 Wildlife reserve: National parks, game reserves etc.
- 4 Shifting cultivation: Land where there is evidence of slash and burn or recent farming activities but area is abandoned.
- 5 Agriculture, including agro forestry: Land with crops and trees or livestock in the same management unit.
- 6 Grazing land: Land with livestock on it or pasture land.
- 7 Built-up areas: Urban or rural or mixed. Including roads, buildings, power lines etc.
- 8 Water body or swamp: Permanent, seasonal or swamp.
- 99 Other land: To be specified in Remarks.

FRA land use/cover class

FRA land use/cover classis recorded on all land use classes. According to the FRA guidelines, the land is divided into *forest* and *other wooded land* according to the tree height and crown coverage. Land falling neither into the *forest* nor the *other wooded land* classes is classified as *other land*.

Code	Description	Explanation
11	Forest (FRA)	Land spanning more than 0.5 hectares with trees higher than 5 meters and a canopy cover of more than 10 %, or trees able to reach these thresholds in situ . It does not include land that is predominantly under agricultural or urban land use
12	Forest (Kenya)	Land spanning more than 0.5 hectares with trees higher than 2 meters and a canopy cover of more than 15 %, or trees able to reach these thresholds in situ . It does not include land that is predominantly under agricultural or urban land use
2	Other wooded land	At maturity stage the height of trees are at least 5 meters and a canopy cover of 5–10 %; or with a combined cover of shrubs, bushes and trees above 10 %. Other wooded land must exceed 0.5 hectares in size. It does not include land that is predominantly under agricultural or urban land use
3	Other land	All land that is not classified as “Forest”, “Other wooded land” or “Other land with tree cover”
4	Other land with tree cover (sub-category of “Other land”)	Land classified as “Other land”, spanning more than 0.5 hectares with a canopy cover of more than 10 % of trees able to reach a height of 5 meters at maturity. E.g. parks, wooded yards, groves
5	Inland water bodies	Inland water bodies generally include major rivers, lakes and water reservoirs

Vegetation type

Vegetation type is recorded on all land use/cover classes.

Table 5. Vegetation types.

Code (numeric)	Code (text)	Land use	Land cover	Crown cover	Description
101	FnD	Forestland	Natural forest	Dense	Crown cover $\geq 65\%$
102	FnM			Medium	Crown cover 40–64%
103	FnL			Low	Crown cover 10–39%
111	FbD		Bamboo forest	Dense	Crown cover $\geq 65\%$
112	FbM			Medium	Crown cover 40–64%
113	FbL			Low	Crown cover 10–39%
121	FmD		Mangrove forest	Dense	Crown cover $\geq 65\%$
122	FmM			Medium	Crown cover 40–64%
123	FmL			Low	Crown cover 10–39%
131	FpD		Plantation forest	Dense	Crown cover $\geq 65\%$
132	FpM			Medium	Crown cover 40–64%
133	FpL			Low	Crown cover 10–39%
134	FpP				PELIS
201	WcD		Woodland	Closed	Dense
202	WcM	Medium			Crown cover 40–64%
211	WoM	Open		Medium	Crown cover 15–39%
212	WoL			Low	Crown cover $< 15\%$

301	Ca	Cropland	Agro-forestry		Home gardens with multi-storey tree covers shading e.g. bananas, coffee etc.
302	Cpc		Perennial crops		Monocultures and mixed crops of, e.g., tea, oranges, nuts etc.
303	Cac		Annual crops		Various herbaceous crops, e.g. cotton, flower plantation, maize, millet etc.
401	Gw	Grassland	Wooded		Grazing, hunting, recreation
402	Gb		Bushed		
403	Go		Open		
501	Bh	Build-up land	Human settlement		
502	Bi		Infrastructure		All other developed land, e.g. air fields, power lines, roads etc.
601	Wao	Waterbodies	Ocean		
602	Wai		Inland water		Lake, river
603	Waw		Wetland		Swamps, seasonally inundated, other
700	Ol	Otherland			Bare soil, rock

Human impact

Human impact is recorded if it has happened at a maximum of 3 years before the laser data acquisition, i.e. between February 2011 and February 2014 in this case. Human impact refers to disturbance or changes in the forest stand composition, structure. Ideally laser ground truthing is carried out immediately after data acquisition. In this case at least 7 months have passed since the laser scanning. This attribute helps to understand if there would be considerable differences between field and remote sensing data. E.g. recently planted, fast growing trees' height growth might cause mismatch between the data sets.

- 0 No impact (no cutting or other impact; or the cutting has happened before February 2011)
- 1 Selective cutting
- 2 Clear felling
- 3 Shifting cultivation
- 4 Planting
- 5 Burning
- 6 PELIS
- 99 Other, specify in Remarks

4.4.2 Tree measurements

Both living and dead trees on all sample plots within 15 m radius with DBH \geq 5 cm will be sampled. Stand ID, species name, DBH and quality are recorded for all trees on all sample plots. Additionally tree positions, i.e. the distance and the bearing from plot centre are recorded.

A tree is in the plot if the estimated centre point of its base is inside the plot boundary. **Plot radii are corrected for each tally tree** unless the crew uses an instrument that can automatically calculate the right distance (e.g. TruPulse). (Note: read more in the section *Slope correction*.)

All trees within the sample plot's borders are recorded, both living and standing dead trees. Every 5th tree on the sample plot is selected as a sample tree. The 1st tally tree on each sample plot is the first sample tree, then the 6th, etc. Note, in case the 5th tree is dead or broken, the next living, unbroken tree is selected as a sample tree but the counting of next sample tree continues from the original (dead/broken) 5th tree.

The data collection starts at the sample plot starting point (plot centre) and continues from the North in clockwise direction. First, all tally trees are measured and possible sample trees are marked with coloured ribbon. Secondly, all marked sample trees are measured. Additional measurements for sample trees are bole height, total height, stump diameter and stump height.

Cactuses and palms are recorded as trees. Information about bamboos is filled into the Bamboo Field Form.

Species names are recorded in the field for every tree. If a tree species is unknown to the crew, the team leader can take a photo of the particular tree and ask advice later from a botanist. The crew can also collect leaf, flower and/or fruit samples.

The recording of species names on all field forms should follow these rules:

- Scientific genus and species name should be recorded whenever possible;
- If exact species is not known, teams must write at least the scientific genus name;
- When exact species is not known, genus names must always be followed by "sp." (e.g. *Shorea* sp.) to indicate it is a scientific name;
- If genus name is also not known, common name may be written;
- If species is completely unknown, enter '?' as code; local name and indicate which Kenyan language (later the common and scientific names can be found out from this information)
- When taking samples of unknown species, always write the sample plot number, form name and tree number, so that data can be reconciled later. Use waterproof ink on samples to avoid data loss due to rain or humidity.
- **New species which are not in the tree species checklist, but correctly identified by the botanist should be added on the appropriate page by the botanist.**

Tree height measurement may be carried out by means of several instruments (Laser Ace, Blume-Leiss, Suunto, Haga, electronic range finders). *Laser Ace* and Suunto hypsometer were used in the pilot inventory. Special care must be taken when measuring trees that are leaning or growing on a slope (Figure 16).

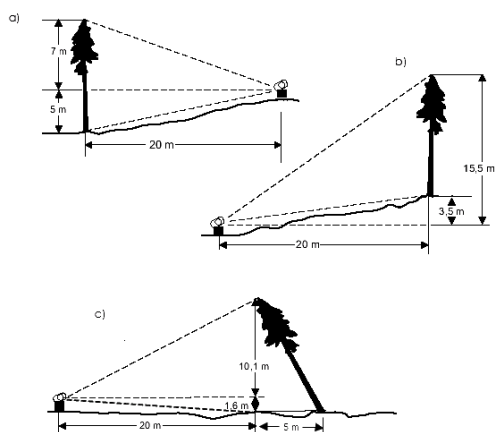

Figure 16. Tree height measurements.

Obtain the height of a tree by (a) adding the results above and below the horizontal measurement (7.0+5.0); (b) subtracting from the total the difference between the base of the tree and the horizontal line (15.5-3.5); and (c) By applying the Pythagorean Theorem. Measure first the height of the tree top, then measure the horizontal distance from the stump point to the top point projected on the horizontal level. Apply equation: $H = \sqrt{(\text{Height}^2 + \text{Distance}^2)}$.

TREE FORM

Tree data is recorded on all land use classes.

Sample plot number

Sample plot number from the inventory field map.

Stand

Code indicating the stand in the sample plot. The sample plot is shared into several stands in case it is situated on the border of more than one land use or vegetation type.

- 1 Stand where the sample plot's centre point is located
- 2 The second stand
- 3 The third stand (etc.)

Tree number

Tree number, starting from number 1 in each sample plot

Quality

Tree quality is an essential variable for the selection of tally trees. Quality status is recorded for every sample tree.

- 1 Living tree
- 2 Broken tree
- 3 Dead tree (standing)

Sample tree

Code whether tally tree is sample tree or not. Note broken or dead tree cannot be a sample tree.

- Y Tally tree is a sample tree (additional measurements are needed)
- N Tally tree is not a sample tree

Species code

Tree species check list. If species is completely unknown, enter '?' as code

Species name

Scientific genus and species name are recorded. If genus name is unknown, common name may be written. If not known give local name and the dialect then refer later (e.g. Kikuyu dictionary of trees and shrubs by Norman Gachathi KEFRI).

Tree diameter, DBH (mm)

Tree diameter is measured over bark, at 1.3 m height above the seeding point i.e. usually ground with the exception of particular cases mentioned below. If bark does not exist estimate the bark thickness and add it to the diameter. Measurement is carried out using preferably a diameter tape or a calliper. Both devices should have metric scale and the smallest unit in millimetres. Diameter is recorded in millimetres. If a calliper is used, the measurement is always carried out at a right angle to the sample plot's centre point (Figure 17), also for non-circular shape trees, but care should be taken to avoid conscious bias in measuring irregular shaped trees. A diameter tape is the best for irregular diameter trees to ensure consistency of measurements. If a tree is leaning on flat terrain, the measurement point is at that side where tree leans (Figure 18). Make sure the calliper tightly holds the stem, in order to prevent the calliper clasps from grasping without compressing the bark.

If the diameter tape is used, make sure it is not twisted and is well stretched around the tree in a perpendicular position to the stem. Remove climbers and loose bark before taking measurements. Nothing must prevent a direct contact between the tape and the bark of the tree to be measured. When a tree is growing on a slope, the measurement point is located at the upper side of the slope (Figure 19).

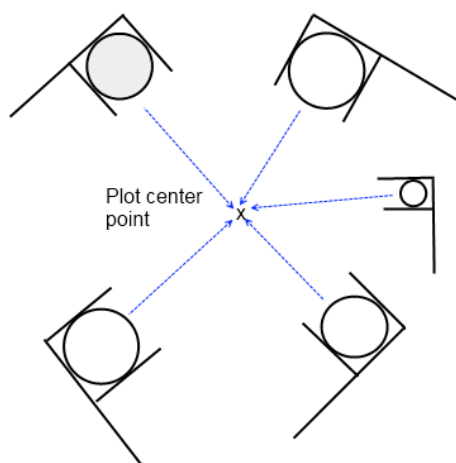

Figure 17. Measurement of DBH with calliper.

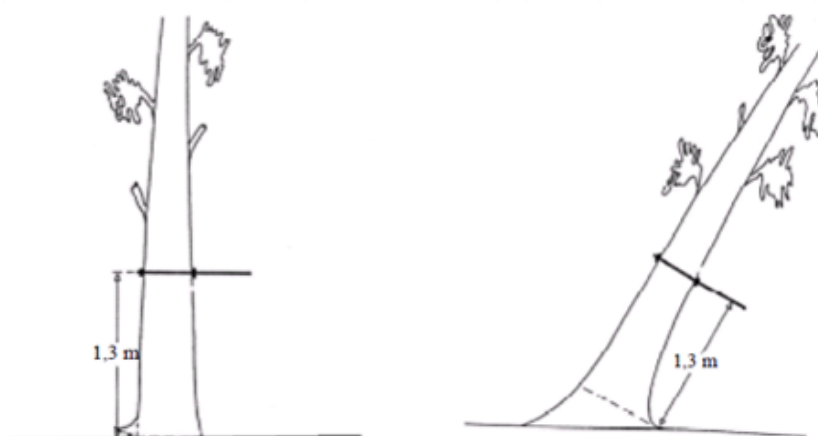

Figure 18. Diameter measurement in flat terrain.

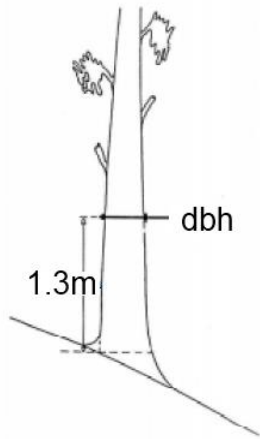

Figure 19. Diameter measurement of a tree on slope

There are several cases where a **forked tree** exists. The first thing is to determine the point where the tree forks.

If the fork originates (the point where the core is divided) below 1.3 m height, each stem reaching the required diameter limit will be considered as a separate stem to be measured, and the diameter is measured at 1.3 m height (Figure 20).

A living stem can be a sample tree. For a forked sample tree record the stump diameter at the default stump height level (15 cm above ground). This stump diameter usually refers to the stump diameter of the whole tree. If a forked sample tree originates below 15 cm, then write a remark to that stem as '**fork below 15 cm**'.

A fork can be dead or alive. Record this information into Quality.

If a fork originates at 1.3 m or a higher, the tree will be counted as a single tree. The diameter measurement is thus carried out **below** the forks' intersection point, just below the bulge that could influence the DBH (Figure 21).

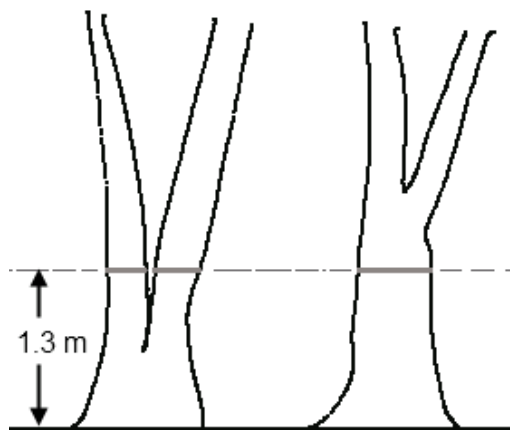

Figure 20. Diameter measurement points for forked tree.

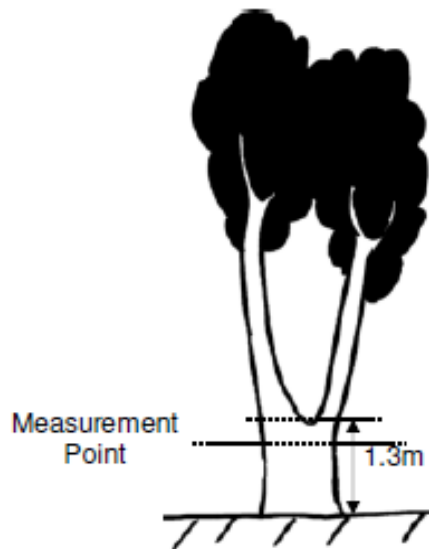

Figure 21. Examples of forks' intersection at the 1.3 m height.

If a tree is leaning but isn't lying on the ground measure it as a forked tree (measure the forks as in Figure 18, leaning tree). If the tree is lying on the ground, each shoot should be considered as a separate tree (Figure 22).

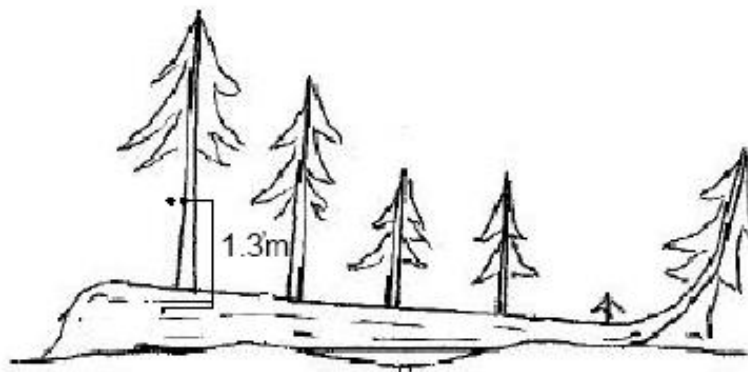

Figure 22. Diameter measurement of living tree lying on the ground with branches growing from the main stem

Coppice shoots are considered similarly as forked trees. The measuring height is 1.3 m above the seedling point (Figure 23).

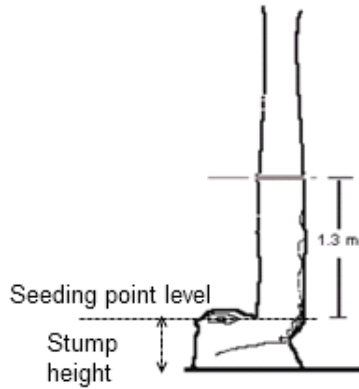

Figure 23. Diameter and stump height measurements of coppice tree.

For trees with an enlarged stem base or buttressed tree: diameter is measured at 30 cm height above the enlargement or main width of buttress, if the buttress/enlargement reaches more than 90 cm height above the ground (see Figure 24).

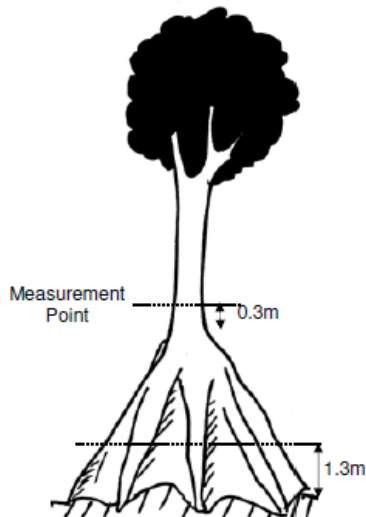

Figure 24. Diameter measurement of a tree with large buttress.

Trees with bulges, wounds, hollows and branches, or other reasons causing irregular shape at 1.3 m height, are to be measured above and beneath the deformation, and the average of both is the calculated as DBH of the tree (Figure 25). A case of damaged and broken stem where the DBH measurement is done below 1.3 m is presented in Figure 26.

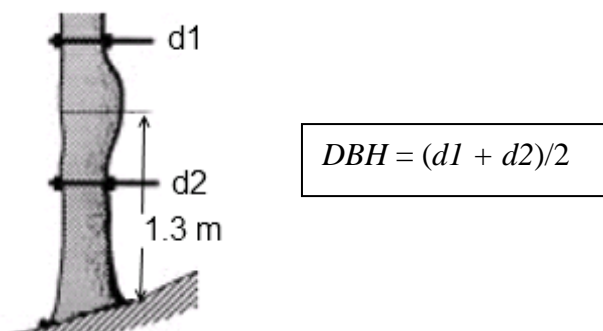

Figure 25. Diameter measurement of deformed trees.

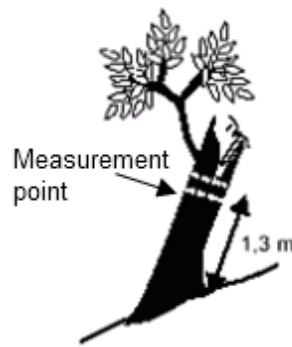

Figure 26. Diameter measurement of a damaged and broken stem.

Height of broken stem (m)

Only for broken trees

The height of a broken stem is measured from the seeding (base) point to the top of the stem and recorded in metres with 0.1 precision. The height is used for improved volume estimation for broken trees.

Distance (m)

The horizontal distance is measured from the sample plot's centre to the side of the tree, which is facing the plot centre at the BH (1.3 m). Distance is recorded in metres with 0.01 precision.

Bearing (degrees)

The bearing from the sample plot's centre to the centre of the tree at the DBH (1.3 m) is recorded with the compass (360 degrees).

Additional measurements for sample trees only:

Stump diameter (mm)

Sample tree

Stump diameter is measured at the top of the stump (i.e. at the stump height). Diameter is recorded in millimetres.

Stump height (cm)

Sample tree

Stump height is the level of the upper most root collar. If no root collars exist, stump height is expected to be 15 cm from the ground level. Stump height is recorded in centimetres

Bole height (m)

Sample tree

Bole height refers to merchantable height that is defined as the distance from the base of the tree to the first occurrence of the lowest point on the main stem, above the stump, where utilization of the stem is limited by branching or other defect. Bole height is recorded in metres with 0.1 precision.

Total height (m)

Sample tree

Total height is measured from the seeding (base) point to the top of the tree. If the seeding point is higher than the ground level (e.g. in case where a tree growing on the top of a stone), the tree height is measured from the seeding point. Total height is recorded in metres with 0.1 precision.

4.4.3 Small trees

Information on small trees are measured and recorded on four circular 2.82 m radius subplots. The subplot centres are located in 7 m distance from the sample plot centre (Figure 9). . The data is collected separately for living and dead trees with a height of at least 1.3 m and a DBH of less than 50mm.

Note: only record the average height, diameter and amount of living and dead trees in each subplot, no need to separate counts by species or origin!

SMALL TREES FORM

Sample plot number

Sample plot number from the inventory field map

Stand

Code indicating the stand in the sample plot. The sample plot is shared into several stands in case it is situated on the border of more than one land use type.

- 1 Stand where the sample plot's centre point locates
- 2 The second stand
- 3 The third stand (etc.)

Small trees subplot position

Indicate the position of the sub plot (north, east, south or west). If the cardinal directions couldn't be used, indicate the nearest cardinal direction.

Quality of small trees

Quality of small trees in the subplot.

- 1 Living
- 2 Dead

Average diameter (mm)

$h \geq 1.3 \text{ m and DBH} < 50 \text{ mm}$

Average diameter of small trees in the subplot.

Average height (m)

$h \geq 1.3 \text{ m and DBH} < 50 \text{ mm}$

Average height of small trees in the subplot with 0.1 precision.

Number of small trees

$h \geq 1.3 \text{ m and DBH} < 50 \text{ mm}$

Count of small trees in the subplot.

4.4.4 Shrubs

SHRUBS

Shrubs data are recorded on all vegetation types. The crew records the information inside the sample plot, radius 15 m.

Sample plot number

Sample plot number from the inventory field map

Stand

Code indicating the stand in the sample plot. The sample plot is shared into several stands in case it is situated on the border of more than one land use type.

- 1 Stand where the sample plot's centre point is located
- 2 The second stand
- 3 The third stand (etc.)

Shrub coverage

Shrub coverage refers to the vertical projection of the shrub canopies as percentage of the total ground area. This parameter is usually visually estimated, but if the use of spherical densiometer is possible, this device can also be used.

- 0 No data, not applicable
- 1 < 10%, very open shrub canopy cover
- 2 10%–39%, open shrub canopy cover
- 3 40%–69%, sparse shrub canopy cover
- 4 ≥ 70%, closed shrub canopy cover

Mean shrub height (m)

Mean shrub height is estimated and recorded in metres (0.1 m precision).

4.4.5 Bamboo

Bamboo data are recorded whenever applicable. Information on bamboo shoots taller than 1.3 m is measured within the sample plot with a radius of 15 m. In case bamboo is growing in clumps, i.e. groups having one source or base, variables are first measured by clumps. Count, average diameter at breast height (1.3 m above ground) and height by species and maturity classes in a clump is first marked on a notepaper. After measuring all the clumps inside the plot, the total amounts and average diameters and heights by species and maturity classes are recorded to the field computer.

If there are so many bamboos on the sample plot, that it is not feasible to measure them by clumps, calculate the averages by species and maturity classes by selecting three shoots per class, representing minimum, medium and maximum DBH and calculate the averages using the three measurements.

In case bamboos are evenly situated (no groups/clumps) in the sample plot area, two subplots, with radius of 2.82 metres situated in west and east in 7 meters distance from the sample plot centre, can be used to calculate all bamboos. Note you can use two of the small trees subplots for this purpose. Sum the count of bamboos in these two subplots and multiply by 14 to get the number of bamboos in the sample plot (15 m). Note bamboos with differences in species and maturity, diameter and height classes are recorded separately. Examples of bamboos of different maturity classes are presented in Figure 27.



Figure 27. On Left picture is “Mature bamboo” and on the right is “young bamboo”.

If a bamboo was cut and it is possible to recognise the pieces, count it as one. If dead bamboos' average height or DBH cannot be estimated due to removal of parts of their stems, calculate the average of the averages of the other maturity classes.

Sample plot number

Sample plot number from the inventory field map.

Stand

Code indicating the stand in the sample plot. The sample plot is shared into several stands in case it is situated on the border of more than one land use or vegetation type.

- 1 Stand where the sample plot's centre point is located
- 2 The second stand
- 3 The third stand (etc.)

Species code

Bamboo species check list.

Species name

Scientific genus and species name are recorded. If genus name is unknown, common name may be written.

Maturity

Observation of Bamboo status.

- Y Young: Green in colour and not yet developed leaves.
- M Mature: Brown in colour and with leaves and branches.
- O Old: Greyish in colour and has moulds on the stems. Leaves are still green.
- D Dead: Greyish in colour with mould on the stem. Leaves are dry or completely dropped.

Average diameter (mm)

Average diameter of the bamboos at 1.3 m above ground (DBH) in the species and maturity class in centimetres.

Average height (m)

Average height of the bamboos in the species and maturity class in metres (0.5 meters precision).

Number of stems

Number of bamboo stems in the species and maturity class.

4.4.6 Climbers

Climbers can have a remarkable share of the biomass in certain areas, especially in natural forests. Climbers with at least 50 mm DBH will be recorded on the sample plot. Record separately living and dead climbers. In case climbers cross over the sample plot border, only the length inside the sample plot is measured. In case there are similar individuals, record the number of stems, average diameter and average length.

Sample plot number

Sample plot number from the inventory field map.

Stand

Code indicating the stand in the sample plot. The sample plot is shared into several stands in case it is situated on the border of more than one land use or vegetation type.

- 1 Stand where the sample plot's centre point is located
- 2 The second stand

3 The third stand (etc.)

Quality

Quality of climbers.

- 1 Living
- 2 Dead

Species code

Climber species check list.

Species name

Scientific genus and species name are recorded. If genus name is unknown, common name may be written.

Count of similar climbers

Count of similar climbers.

Diameter (mm)

Diameter of the climber at 1.3 m above ground (DBH) or 1.3 m distance from the seeding point in millimetres. Record average diameter if count is more than 1.

Length/height (m)

Length/height of the climber in metres (0.1 m precision). Record average length if count is more than 1.

REFERENCES

- British Columbia Ministry of Forests 2008.** Glossary of Forestry Terms in British Columbia. Province of British Columbia, Canada. Available at:<http://www.for.gov.bc.ca/hfd/library/documents/glossary/>
- Commonwealth of Australia. 2002.** Field measurement procedures for carbon accounting. Bush for Greenhouse Report 2. Australian Greenhouse Office.
- FAO. 2007.** Global Forest Resources Assessment 2010 – Specification of National Reporting Tables for FRA 2010. FRA Working Paper No 135. Rome. 51 p.
- FAO. 2008.** Technical Review of FAO's Approach and Methods for National Forest Monitoring and Assessment (NFMA). By Erkki Tomppo and Krister Andersson. National Forest Monitoring and Assessment Working Paper NFMA 38. Rome
- FAO. 2009.** National Forest Monitoring and Assessment – Manual for integrated field data collection. Version 2.3. National Forest Monitoring and Assessment Working Paper NFMA 37/E. Rome.
- Forest Survey of India. 2002.** Manual of Instructions for Field Inventory. Forest Survey of India (FSI), Dehradun, India.
- IPCC 2008.** 2006 IPCC Guidelines for National Greenhouse Gas Inventories – A primer. Prepared by the National Greenhouse Gas Inventories Programme, Eggleston H.S., Miwa K., Srivastava N. and Tanabe K. (eds). Publisher: IGES, Japan.
- METLA 2006.** VMI10 Maastotyöohje. Field Manual for NFI-10 in Finland. Finnish Forest Research Institute. Helsinki, Finland. (in Finnish).
- Michalak, R. 2008.** Comparison of the scope, terms, definitions and classifications applied for the FAO Global Forest Resources Assessment 2010 and the MCPFE/UNECE/FAO Report on State of Europe's Forests 2007. Part I - Definitions and classifications structured according to FRA reporting tables. UNECE/FAO Timber Section, Geneva. 38 p.
- Mori, Sah, B.P., Hämäläinen, J., Latva-Käyrä, P., Kinyanjui, M., Muchiri, M., Musila, W. and Wamichwe, K. 2012.** Forest Inventory Lecture Note and Manual. The Forest Preservation Program for the Republic of Kenya. PASCO Corporation. 86 p.
- Raae, K. Christensen, P., Phuong, V.T. and Dien, V.T. 2010.** Technical Report on Technical Assistance in the Development of the National REDD Programme of Vietnam: Component of Collecting Information and Analyzing Trends of Forest Resources and Forest Carbon Stock for Establishment of the Interim Baseline Reference Scenarios. Vietnam Administration of Forestry, Hanoi. 38 p.
- Report on National Forest Resource Mapping and Capacity Development for the republic of Kenya, Volume 2. 2013.** Forest Preservation Programme. PASCO Corporation. Rep No.: KEF09/11494/01. 160 p.
- Setje-Eilers, U. 2008.** Forest Resource Inventory Field Manual (province level). Forest for Livelihood Improvement in the Central Highlands (FLITCH) Project. Technical Report. 28 p. + annexes.
- Setje-Eilers, U. 2012.** Proposal on Information Standard for Forest Resource Inventory. Development of Management Information System for Forestry Sector (FORMIS) Project. Version February 2012. 29 p.
- Tomppo, E., Olsson, H., Ståhl, G., Nilsson, M., Hagner, O. & Katila, M. 2008.** Combining national forest inventory field plots and remote sensing data for forest databases. Remote Sensing of Environment 112: 1982-1999.
- Woodall, C.W., Rondeux, J., Verkerk, P.J. & Ståhl, G. 2006.** Estimating Dead Wood During National Forest Inventories: A Review of Inventory. Methodologies and Suggestions for Harmonization. Proceedings of the Eighth Annual Forest Inventory and Analysis Symposium.

Annex 1. Slope Correction

Slope corrections for distance measurements. The table provides correct distances for horizontal distances in function of slope. E.g. the distance correction for a horizontal distance of 15 m with a slope of 20% is 15.3 m. For other horizontal distances, other than in the table, please use Factor f: multiply the horizontal distance by the slope correction factor f. E.g. aim is to find horizontal distance of 7 m on a terrain with slope of 50% → 7 * 1.118 = 7.83 m.

Slope		Factor	Horizontal distance (m)					
%	degrees	f	2	5	10	15	20	50
5	2.9	1.001	2.00	5.01	10.01	15.02	20.02	50.06
10	5.7	1.005	2.01	5.02	10.05	15.07	20.10	50.25
15	8.5	1.011	2.02	5.06	10.11	15.17	20.22	50.56
20	11.3	1.020	2.04	5.10	10.20	15.30	20.40	50.99
25	14.0	1.031	2.06	5.15	10.31	15.46	20.62	51.54
30	16.7	1.044	2.09	5.22	10.44	15.66	20.88	52.20
35	19.3	1.059	2.12	5.30	10.59	15.89	21.19	52.97
40	21.8	1.077	2.15	5.39	10.77	16.16	21.54	53.85
45	24.2	1.097	2.19	5.48	10.97	16.45	21.93	54.83
50	26.6	1.118	2.24	5.59	11.18	16.77	22.36	55.90
55	28.8	1.141	2.28	5.71	11.41	17.12	22.83	57.06
60	31.0	1.166	2.33	5.83	11.66	17.49	23.32	58.31
65	33.0	1.193	2.39	5.96	11.93	17.89	23.85	59.63
70	35.0	1.221	2.44	6.10	12.21	18.31	24.41	61.03
75	36.9	1.250	2.50	6.25	12.50	18.75	25.00	62.50
80	38.7	1.281	2.56	6.40	12.81	19.21	25.61	64.03
85	40.4	1.312	2.62	6.56	13.12	19.69	26.25	65.62
90	42.0	1.345	2.69	6.73	13.45	20.18	26.91	67.27
95	43.5	1.379	2.76	6.90	13.79	20.69	27.59	68.97
100	45.0	1.414	2.83	7.07	14.14	21.21	28.28	70.71
105	46.4	1.450	2.90	7.25	14.50	21.75	29.00	72.50
110	47.7	1.487	2.97	7.43	14.87	22.30	29.73	74.33
115	49.0	1.524	3.05	7.62	15.24	22.86	30.48	76.20
120	50.2	1.562	3.12	7.81	15.62	23.43	31.24	78.10
125	51.3	1.601	3.20	8.00	16.01	24.01	32.02	80.04
130	52.4	1.640	3.28	8.20	16.40	24.60	32.80	82.01